

BelFone

www.belfone.com



BF-326

Analog Two-way Radio

Notice to the user

Government law prohibits the operation of unlicensed radio transmitters within the territories under government control.

Illegal operation is punishable by fine or imprisonment or both.

THANK YOU

We are grateful you choose BelFone series professional radio communications products!

Since 1989, BelFone has been dedicated to research and explore in the field of radio communication technology throughout the decades, and has developed leading smart technology in the industry. Underpinned by research, development and design geared towards modern complicated and changeable communication environment, it is capable of tailoring specific communication solutions to your needs based on features of your industry. Superior products with outstanding performance may help you control the overall situation, while providing you with the best choice for smart scheduling and instructions communicating.

This manual is applicable to
BF-326 series

WARNING!

◆ In explosive atmospheres (flammable gas, dust particles, much powder area, etc.), please turn the power off.

Instructions before Use

It's important for the operator to be aware of and understand hazards common to the operation of any radio. Please observe the following safety precautions to prevent radio damage and personal injury. The following precautions shall be observed during operation, service and repair of this radio.

- ◆The recommended usage rate is 1 minute for TX and 4 minutes for RX, when the radio is used in the transmission mode for many hours continuously, the radiator and chassis will become hot, allow the rear panel of the radio to contact a surface of low melting point /low Ignition point.
- ◆Don't leave the transceiver in direct sunlight for a long time. Also, don't place the transceiver on sources of extremely heat, damp, dusty area, or unstable surfaces.
- ◆In areas where the use of radio devices is restricted or warned,, please obey the regulation and turn off the transceiver.
- ◆Use of the radio while driving may be against traffic laws in some countries, please check local traffic laws before using the radio while driving.
- ◆If there is any problem with the radio, please turn the radio off immediately. Then contact the local dealer/technician. Do not modify this radio unless instructed by this manual. Refer to a certified technician only for service.
- ◆If secondary development is required, please contact BelFone or the local dealer for technical assistance.
- ◆Please keep the surface of radio clean and dry. To clean the radio, use a damp fabric soaked in mild washing liquid..

Contents

Unpacking and Device Inspection	01
Installation of Accessories	02
Getting Acquainted	05
Basic Operation	07
Turning the power on /off	07
Adjusting the Volume	07
Selecting a Channel	07
Transmitting.....	07
Receiving.....	08
Functions and Operations	09
Scan	09
Monitor	09
Bandwidth.....	09
Busy Channel Locking(BCL)	10
Frequency Matching.....	10
Language	10
Squelch Level.....	10
Time-Out-Time(TOT).....	11
VOX.....	11
Battery Saver.....	11
Low Battery Warning	11
CTCSS/CDCSS.....	12
CTCSS Standard Frequency Table.....	13
CDCSS Standard Code Table.....	14
Specifications	15
Statement	16

Unpacking and Device Inspection

Note: The following instructions regarding unpacking are only for BelFone's distributors, and service agencies or factories authorized by BelFone.

After carefully unpacking the transceiver, identify the items listed in the table below. If any items are missing or have been damaged during shipment, please contact dealer immediately.

Accessories

Items	Quantity
Antenna	1
Li-ion Battery	1
Charging cable	1
Belt Clip	1
Screws	1
User Manual	1
Warranty Card	1
Certificate	1



Antenna

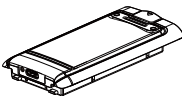

Li-ion Battery

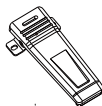

Belt Clip



Charging cable



Screws

Installation of Accessories

Installatiing/ Removing the Antenna

Hold the supplied antenna by its base, then screw it into the connector on the top panel of the radio until fasten.

Turn the antenna anti-clockwise to remove it.



Installing/ Removing the Belt Clip

Attach the belt clip using the two supplied 2.5 * 4mm binding screws.

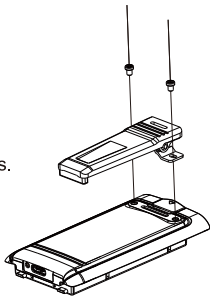

Attaching/Removing the Strap

Thread the hand strap to the loop back of the two-way radio.

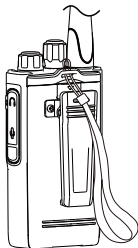

Attaching/Removing the Battery

Warning!

- Don't short-circuit the battery, it may get damaged or burst into flame;
- Never attempt to remove the casing from battery, the battery terminals may short circuit;
- Battery is flammable objects, don't throw it into fire or don't use it on dangerous area.

Match the guides of the battery with the corresponding grooves on the upper rear of the radio, then press the battery until a click is heard to lock it in place.



To remove the battery, please turn the power off then press the latch to unlock the battery and pull the battery away from the radio.

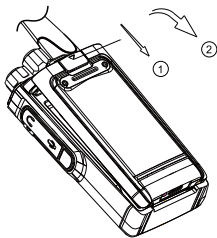

Note: Don't attach / remove the battery if the radio turned on.

Battery Information

The new battery hasn't been fully charged before shipped, please charge more than 5 hours at the first use. The maximum battery capacity and performance is achieved after three full charge/discharge cycles. If the battery power runs low, please recharge the battery.

Applicable Battery

To reduce the risk of injury, please only use the battery and charger specified by BelFone, other batteries may burst, causing body injury and property damage.

Battery Tips

1. When charging battery, keep it at a temperature among 5°C to 40°C. Temperature out of the limit may cause battery leakage or damage.
2. When charging a battery attached to a radio, turn the radio off to ensure a full charge.
3. Do not cut off the power supply or remove the battery when charging a battery.
4. Never charge a battery that is wet, please dry it with soft cloth prior to charge.
5. If the battery is fully charged, the operating time is noticeably shorter than normal performance; it is time to buy a new battery.

To Prolong Battery Life

1. Battery performance will be greatly decreased at a temperature below 0°C, and a spare battery is necessary in cold weather. The battery that couldn't work properly in the cold environment may work under room temperature, so keep it for later usage.
2. The dust on the battery contact may cause battery breakdown, please use a clean dry cloth to wipe it before attaching the battery to the radio.

Battery Storage

1. Please fully charge the battery before keep it for a long time to avoid battery damage due to the over-discharge.
2. Please recharge the battery after several months' storage to avoid battery

capacity reduction due to over-discharge.(NI-MH batteries:3 months, Li-Ion& Li-polymer batteries: 6 months)
3.Please keep the battery in a cool, dry place under room temperature to reduce self-discharge.

Charging the Battery

The charger only specified by BelFone is allowed to use. The charge indicator on the battery indicates the charging progress.

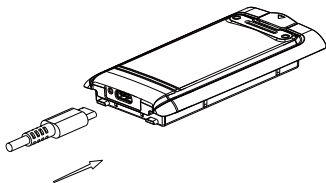

Charge Steps:

- 1.Plug the AC connector of the switching power into the AC outlet socket.
- 2.Plug the charging cable into the USB Type-C interface of the battery.
- 3.Make sure the battery is connected to the charger, and the charging process initiates when the charger indicator glows red.
- 4.Please remove the battery when the charger indicator glows green which means the battery has been fully charged,.

Attaching the Speaker /Microphone

Open the accessory port cover, then plug the speaker/MIC or programming cable into the port.

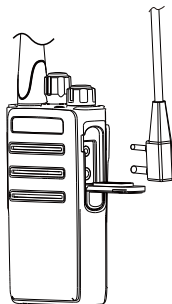

Getting Acquainted

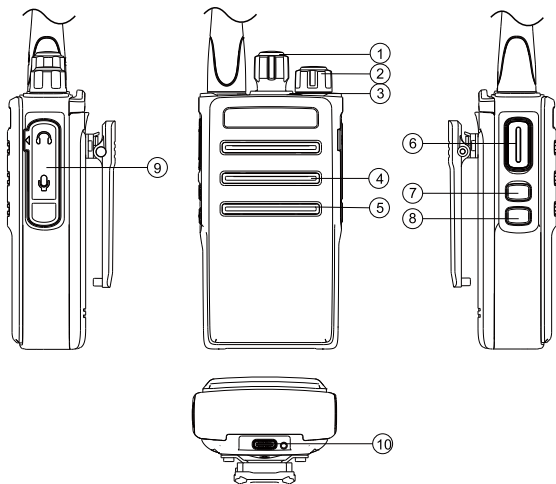

① Channel Selector Knob

Turn the knob to select channel 1-16.

② Power switch/volume adjust keys

Rotate clockwise to power on, after the radio is powered on, rotate clockwise to increased volume, anti-clockwise to decrease the volume. Rotate anti-clockwise fully to power off.

③ LED Indicator

When the radio transmitting the LED will glow red, when receiving the LED will glow green.

④ **Speaker**

⑤ **MIC**

⑥ **PTT key**

Press and hold down the PTT key then speak into the microphone to transmit.

⑦ **MONI (Monitor) Key**

Press the key to monitor selected channel.

⑧ **SCAN Key**

Long press the key to turn on the scanning function, and long press again to turn off the scanning function.

⑨ **MIC-SP-USB Jack**

Connect to optional speaker/MIC and USB programming cable.

⑩ **USB Type-C Interface**

Connect the charging cable for charging.

Basic Operation

Turning the power on /off

Rotate the power switch/volume adjusting keys clockwise to power on.

Rotate the power switch/volume adjusting keys anti-clockwise to power off.

Adjusting the Volume

After the radio is powered on, rotate the power switch/volume adjust keys to adjust the volume level. Rotate the knob clockwise to increase the volume, or rotate the knob anti-clockwise to decrease the volume.

Note: Users can hold down the MONI button for background noise and adjust the appropriate volume according to the background noise.

Selecting a Channel

Rotate the channel selector knob to select channel 1 to 16. Rotate the knob clockwise to increase the channel number, or rotate the knob anti-clockwise to decrease the channel number. You will hear the channel number when the channel is changed.

Note: All channels need to have the channel frequency pre-set on the programming software, otherwise when the channel is empty, the voice of “No channel” will be prompted.

Transmitting

1.Press MONI key to monitor for a moment to make sure the current channel is not occupied by other radio.

2.Press and hold down the PTT key, and then speak into the microphone.

●Hold the radio about 3 to 4 centimeters away from mouth, speak at normal voice level.

- Press and hold down the PTT key, LED indicator glows red when transmitting.
3. Release the PTT key to receive, and the LED indicator glows green when a signal is received.

Receiving

When the channel is being called, the LED indicator glows green and the call can be heard.

- If the signal is weak and the radio is set to a higher squelch level, the call will not be received.
- If the channel has set CTCSS/CDCSS signaling, only calls with the same CTCSS/CDCSS signaling can be heard, and other calls will not be heard.

Functions and Operations

Scan

Scan is used to monitor signals on the radio channels. During scanning, the radio detects signals from channels with the " Scan Add " option set to "On". If a signal is scanned, the radio will remain on that channel until the signal disappears. The scan will resume 5 seconds after the signal disappears, unless a new signal is detected within the delay time.

To begin scanning, you can press and hold the SCAN key for about 2 seconds, a voice will prompt "Scan on" and the indicator light will flash green. Scan starts from the current channel, and increments by channel number, and cycles through the scan. When a signal is detected, it stops on that channel. Press the PTT key during the scanning process, the radio will pause scanning and return to the channel where the last signal was received for transmission. If no valid signal is received during the scanning period, press the PTT key to return to the channel where the scanning started for transmission.

To stop scanning, you can press and hold the scanning button for about 2 seconds, and a voice will prompt "Scan Off" , meanwhile, the indicator light will no longer flash green, and the radio will return to the channel where it was before scanning. Pressing the MONI key or rotating the channel encoder will also automatically turn off scanning.

Monitor

Press and hold the MONI key to monitor weak signals that are difficult to hear during normal operation, or monitor background noise for adjusting the volume level when there is no signal in the channel.

Bandwidth

The radio supports bandwidth setting, which can set each channel interval to wideband (25kHz) or narrowband (12.5kHz)

Note: The bandwidth of the transmitting and receiving channels should be set the same, otherwise the call quality will be affected.

Busy Channel Locking(BCL)

The busy channel locking function is to prevent interference caused by other users transmitting on the current channel. When "None" is set, regardless of channel conditions, pressing PTT can directly transmit. When "carrier" is set, if the current channel is active, pressing the PTT key will result in a voice prompt of " busy channel lockout " and prohibit transmission. When "CTCSS/CDCSS" is set, if the channel receives a signal with the same CTCSS/CDCSS, pressing the PTT key will result in a voice prompt of " busy channel lockout " and prohibit transmission.

Frequency Matching

Simultaneously press the MONI key and scan key, the indicator light will turn red and there will be a voice prompt of "RF ID". The radio will enter the frequency matching mode. At this point, the frequency matching party remains in the transmitting state until the radio indicator light turns green and there is a voice prompt of "success", indicating successful frequency matching. When the red light of the radio automatically turns off and there is a voice prompt of "fail", it indicates that the frequency synchronization has failed. The radio will return to normal working status and users can press the key again to enter the frequency matching function.

Language

When rotating the channel encoder, the radio will broadcast the current channel number, and Chinese or English voice prompts can be selected through programming software.

Squelch Level

The squelch level is used to adjust the noise threshold of the received signal. The higher the squelch level, the stronger the noise suppression is enabled. When the selected squelch level is too high, weaker signals cannot be heard. When the selected squelch level is too low, the signal will appear in the background noise.

Time-Out-Time(TOT)

The TOT function can prevent the current channel from being occupied by a single user for too long. For busy channels, a shorter time-out-time limit can be set. If the continuous transmission time exceeds the set value, the radio will prompt "Time out" and automatically end the transmission.

VOX

The VOX function allows users to transmit without pressing the PTT key. When this function is activated, the transmission operation can be directly initiated through voice, and once the voice stops, the transmission will automatically end. When the environment is noisy, the VOX level can be adjusted to a higher level. When the environment is quiet, the VOX level can be appropriately lowered. When the VOX switch is set to " with headphones on ", headphones need to be plugged in to initiate transmission through voice. When the voice control switch is set to "Open without headphones", it can directly speak into the microphone of the handheld terminal to initiate transmission.

Battery Saver

The radio will automatically enter the power saving mode when it has no any operation for a period of time, which can extend the battery life.

Low Battery Warning

When the battery level gets low, the radio will prompt "Low battery, please charge", please replace or charge the battery in time to avoid affecting normal use,, otherwise the radio will power off automatically if the battery level is too low.

CTCSS/CDCSS

The radio supports CTCSS/CDCSS to guarantee the privacy of the communication. When the CTCSS/CDCSS is set on the channel, voice output is only allowed when the CTCSS/CDCSS transmitted and received match. When the channel is set with CDCSS, the digital sub tone mode can be set as normal signaling or special signaling through the programming software. In normal signaling mode, the encoding rules of digital sub audio adopt universal CTCSS/CDCSS standard rules, while in special signaling mode, the encoding rules adopt special rules. Once the special signaling mode is enabled, please ensure that both the transmitter and receiver enable the special signaling mode, otherwise interoperability cannot be achieved.

Note:

- 1. If there are no special requirements, it is recommended to directly use the normal signaling mode.**
- 2. The radio support non-standard CTCSS/CDCSS, which can be manually input through the programming software, and non-standard CTCSS/CDCSS also support special signaling modes.**

CTCSS Standard Frequency Table

CTCSS No.	Fre. [Hz]	CTCSS No.	Fre. [Hz]	CTCSS No.	Fre. [Hz]	CTCSS No.	Fre. [Hz]
1	67.0	11	94.8	21	131.8	31	186.2
2	69.3	12	97.4	22	136.5	32	192.8
3	71.9	13	100.0	23	141.3	33	203.5
4	74.4	14	103.5	24	146.2	34	210.7
5	77.0	15	107.2	25	151.4	35	218.1
6	79.7	16	110.9	26	156.7	36	225.7
7	82.5	17	114.8	27	162.2	37	233.6
8	85.4	18	118.8	28	167.9	38	241.8
9	88.5	19	123.0	29	173.8	39	250.3
10	91.5	20	127.3	30	179.9		

CDCSS Standard Code Table

CDCSS NO	Positive Code	Negative Code	CDCSS NO	Positive Code	Negative Code	CDCSS NO	Positive Code	Negative Code
1	D023N	D023I	29	D174N	D174I	57	D445N	D445I
2	D025N	D025I	30	D205N	D205I	58	D464N	D464N
3	D026N	D026I	31	D223N	D223I	59	D465N	D465N
4	D031N	D031I	32	D226N	D226I	60	D466N	D466I
5	D032N	D032I	33	D243N	D243I	61	D503N	D503I
6	D043N	D043I	34	D244N	D244I	62	D506N	D506I
7	D047N	D047I	35	D245N	D245I	63	D516N	D516I
8	D051N	D051I	36	D251N	D251I	64	D532N	D532I
9	D054N	D054I	37	D261N	D261I	65	D546N	D546I
10	D065N	D065I	38	D263N	D263I	66	D565N	D565I
11	D071N	D071I	39	D265N	D265I	67	D606N	D606I
12	D072N	D072I	40	D271N	D271I	68	D612N	D612I
13	D073N	D073I	41	D306N	D306I	69	D624N	D624I
14	D074N	D074I	42	D311N	D311I	70	D627N	D627I
15	D114N	D114I	43	D315N	D315I	71	D631N	D631I
16	D115N	D115I	44	D331N	D331I	72	D632N	D632I
17	D116N	D116I	45	D343N	D343I	73	D654N	D654I
18	D125N	D125I	46	D346N	D346I	74	D662N	D662I
19	D131N	D131I	47	D351N	D351I	75	D664N	D664I
20	D132N	D132I	48	D364N	D364I	76	D703N	D703I
21	D134N	D134I	49	D365N	D365I	77	D712N	D712I
22	D143N	D143I	50	D371N	D371I	78	D723N	D723I
23	D152N	D152I	51	D411N	D411I	79	D731N	D731N
24	D155N	D155I	52	D412N	D412I	80	D732N	D732N
25	D156N	D156I	53	D413N	D413I	81	D734N	D734I
26	D162N	D162I	54	D423N	D423I	82	D743N	D743I
27	D165N	D165I	55	D431N	D431I	83	D754N	D754I
28	D172N	D172I	56	D432N	D432I			

Specifications

General	
Frequency Range	UHF: 400-480MHz
Channel Capacity	16
Channel Spacing	25 KHz /12.5 KHz
Operating Voltage	DC 3.7V ($\pm 20\%$)
Battery Capacity	1000mAh
Frequency Stability	$\leq \pm 2.5$ ppm
Antenna Impedance	50 Ω
Dimensions (L×W×H)	53.1(L)* 28.7(W)* 100.7(H)mm
Weight	155g(Including Battery)
Transmitter	
RF Output Power	≤ 2 W
4FSK Modulation	11K ϕ F3E/16K ϕ F3E
FM Modulation	$\leq \pm 2.5$ KHz / ± 5.0 KHz
Adjacent Channel Power	60dB
Audio Distortion	< 5%
Receiver	
Sensitivity	≤ -122 dBm (12dB SINAD)
Intermodulation	≥ 60 dB(Wide)/ 55dB (Narrow)
Adjacent Channel Selectivity	≥ 60 dB(Wide)/ 55dB(Narrow)
Spurious Response Rejection	≥ 60 dB(Wide)/ 55dB(Narrow)
Rated Audio Output Power	0.5W
Audio Distortion	$\leq 5\%$
Environmental	
Operating Temperature	-20 C ~ +60 C
Storage Temperature	-30 C ~ +70 C

Statement

This manual is compiled to be accurate and complete for operator's use. For any doubt, please contact Belfone. We will give you professional answers. As radio communication technologies develop rapidly, Belfone reserves the right to change product design and specification without prior notice to consumers.

Belfone

FUJIAN BELFONE COMMUNICATIONS TECHNOLOGY CO.,LTD.

Add: A-15 Huaqiao Economic Development Zone,
Shuangyang,Luojiang,Quanzhou,Fujian,China

Tel: +86 595 28396717

Fax: +86 595 22771635

Email: overseas@belfone.com

Website: www.belfone.com



RECYCLABLE PACKAGING