

BelFone

www.belfone.com



BF-TD510LF

Digital PMR446 License Free Radio

AVAILABLE OPTIONS:

Car Charger

Hook / Swivel Earpiece

Acoustic Tube Earpiece

Remote Speaker / Microphone

Programming Cable

Multi Charger (6 slots)

Carrying case



Notice to the user

Government law prohibits the operation of unlicensed radio transmitters within the territories under government control.

Illegal operation is punishable by fine or imprisonment or both.

THANK YOU!

We are grateful you choose BelFone series professional radio communications products!

Since 1989, BelFone has been always engaging in research and exploration of radio communications technologies, In order to lead intelligent technologies in the industry. We still make every effort to research and design products according to modern complicated communications environment, and we offer complete and customized communication solutions to clients. Our products will satisfy you because of its excellent performance and outstanding communications strength. No matter what field you are in. You will be Satisfied with the radio.

This manual is applicable to

Digital PMR446 License Free Radio Model:BF-TD510LF

Warning!

- ◆ In explosive atmospheres(inflammable gas, dust particles, much powder area etc.),please turn the power off.

Precautions

It's important that the operator is aware of and understands hazards common to the operation of any radio .Please observe the following safety precautions to prevent radio damage or personal injury. The following precautions shall be observed during operation, service and repair of this radio.

- ◆ The recommended usage rate is 1 minute for TX and 4 minutes for RX, when the radio is used for transmission for many hours continuously, the radiator and chassis will become hot, allow the rear panel of the radio to contact surface of low melting point /low Ignition point object;
- ◆ Don't leave the transceiver in direct sunlight for a long time, don't place the transceiver on extremely heat, damp, dusty area, and don't put it on unstable surfaces;
- ◆ When restriction or warnings are posted regarding the use of radio devices, please obey the regulation turn the transceiver power off;
- ◆ Use of the radio while you are driving may be against traffic laws, please prohibit using it ;
- ◆ If you notice any problems on the radio, please turn off at first. Then contact with local dealer. Do not modify this radio unless instructed by this manual or refer service to a qualified licensed or certified technician only;
- ◆ If you want to use the machine for secondary development, please contact with BelFone's technical engineer or dealer for technical assistance;
- ◆ Please keep the surface of radio is clean and dry, clean the radio using a cloth moistened with clean water and a mild dishwashing liquid.

Content

Supplied Accessories	01
Installation of Accessories	02
Getting Acquainted	06
Basic Operation	07
Turning the power on /off	07
Adjusting the volume	07
Selecting a Channel	07
Selecting a Zone	08
Dual Modes Switching	08
Call	08
Button Setting	09
Functions and Operations	11
Voice Encryption	11
VOX	11
Battery Saver	11
Warning Tones	12
Reject Stranger Call	12
Low Battery Warning	13
Digital Emergency	13
Scan	14
Auto Scan	14
Monitor and Permanent Monitor	14
Message	15
One Touch Call	15
Talk Around	16
TX Power	16
Bandwidth	17
Squelch Level	17
Time-Out-Timer TOT	17
TX Permission	18
CTCSS/CDCSS	18
Dual Capacity Direct Mode	19
Radio Priority-Based Interrupt	19
Alone Worker	20
CTCSS Frequency Table	21
CDCSS Standard Code Table	22
Specifications	23
Statement	25

Supplied Accessories

Notes: The accessories listed below are covered by BelFone dealer authorized BelFone agents or factories .

After carefully unpacking the transceiver, identify the items listed in the table below. If any items are missing or have been damaged during shipment please contact with dealer immediately.

Accessories

Items	Number	Quantity
Antenna		1
Strap		1
Belt Clip		1
Charger		1
Li-ion Battery		1
Screws		1
User Manual		1

Antenna

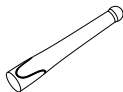

Strap



Charger

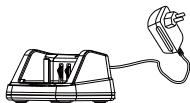

Li-ion Battery



Belt Clip



Screws



Installation of Accessories

Attaching/Removing the belt clip

Attach the belt clip using the two supplied 3*4mm binding screws.

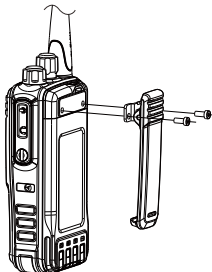

Attaching/Removing the Strap

Thread the hand strap to the loop back of your two-way radio.

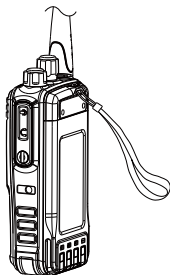

Attaching/Removing the Battery

Warning

- Don't short-circuit the battery, it may cause the battery damaged or burst into flame;
- Never attempt to remove the casing from battery, that avoid to short the battery terminal;
- Battery is flammable objects, don't throw it into fire or don't use it on dangerous area.

Match the guides of the battery with the corresponding grooves on the upper rear of the radio, then press the battery until a click is heard to lock it in place.

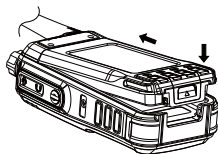

To remove the battery, please turn the power off then press the release latch to unlock the battery pull the battery away from the radio.

Note: Don't attach / remove the battery if the transceiver turned on.

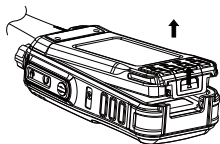

Battery Information

New battery is shipped not fully charged from the factory, please charge your battery before using it, charging a new battery for 5 hours before initial use. The maximum battery capacity and performance is achieved after three full charge/discharge cycles. If you notice the battery power runs lows, please recharge the battery.

Applicable Battery

To reduce the risk of injury, please only use the battery and charger specified by BelFone other batteries may burst, causing bodily injury and property damage.

Battery Tips

- When charging your battery, keep it at a temperature among 5°C-40°C. Temperature out of the limit may cause battery leakage or damage.
- When charging a battery attached to a radio, turn the radio off to ensure a full charge.
- Do not cut off the power supply or remove the battery when charging a battery.
- Never charge a battery that is wet, please dry it with soft cloth prior to charge.
- Even if the battery is full charged, the operating time is noticeably shorter than normal performance; it is time to buy a new battery.

To Prolong Battery Life

1. Battery performance will be greatly decreased at a temperature below 0°C , a spare battery is necessary in cold weather, the cold battery unable to work in this situation may work under room temperature, so keep it for later use.
2. The dust on the battery contact may cause battery breakdown, please use a clean dry cloth to wipe it before attaching the battery to the radio.

Battery Storage

1. Fully charge a battery before you store it for a long time, to avoid battery damage due to over-discharge.
2. Recharge a battery after several months' storage, to avoid battery capacity reduction due to over-discharge. (NI-MH batteries: 3 months, Li-Ion& Li-polymer batteries: 6 months)
3. Store your battery in a cool, dry place under room temperature, to reduce self-discharge.

Charging the battery

Use only the charger specified by the manufacturer, the charge indicator indicates the charging progress.

Charger Status	Charger Indicator
Standby(No-load)	Charge Indicator glows green
Battery is charging	Charge Indicator glows red
Battery is fully charged	Charge Indicator glows green

Charge Steps:

1. Plug the AC connector of the switching power into the AC outlet socket.
2. Place the battery or the radio is attached with a battery in the charger.
3. Making sure the battery is connected to the charger, the charging process initiates when the charger indicator glows red.
4. The charger indicator glows green when the battery is fully charged, please remove the battery then.

Note: While charging the temperature out of the limit the LED indicator of charger will flash red and green; if battery has damaged or battery is not connected to the charger correctly, The LED indicator of charger also will flash red and green

Attaching the Speaker/Microphone

Open the accessory jack cover, then align the plug with the accessory jack and tighten the screw on the plug.

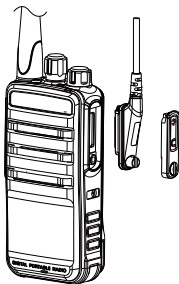

Getting Acquainted

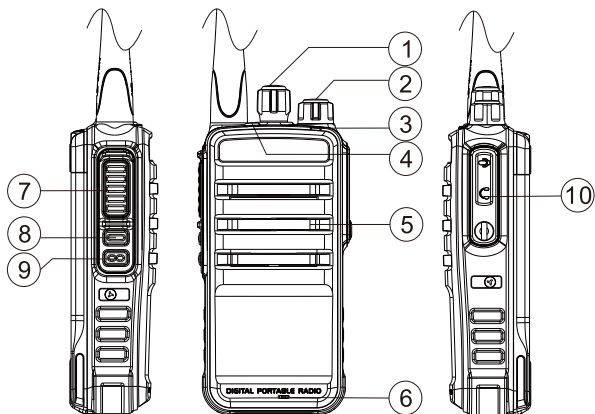

Channel Selector Knob

Turn the knob to select channel 1-16.

Power switch/volume adjust keys

Turn clockwise to switch the radio power on, when the radio is turned on, rotate clockwise to increased volume, counter-clockwise to decrease the volume. Turn counterclockwise fully to switch the radio off.

LED Indicator

When transmitting LED glows red, when receiving LED glows green; when un-programmed LED flashes red; when scanning LED flashes red.

Orange Button

Press to activate the programmable function. (The detailed consult to basic operation)

Speaker

MIC

PTT Key

Press and hold down the PTT key then speak into the microphone to transmit.

Button 1

Press to activate the programmable function. (The detailed consult to basic operation)

Button 2

Press to activate the programmable function. (The detailed consult to basic operation)

MIC-SP-USB Jack

Connect to optional speaker/MIC and USB programming cable.

Basic Operation

Turning the power on /off

Rotate the power switch/volume adjusting keys clockwise to turn the power on.
Rotate the power switch/volume adjusting keys anti-clockwise to turn the power off.

Adjusting the volume

After the radio is power on, you can rotate the power switch/volume adjust keys to adjust the volume level, rotate the knob clockwise to increase the volume, or rotate the knob anti-clockwise to decrease the volume.

Selecting a Channel

Turn the channel selector knob to select channel 1 to 16, rotate the knob clockwise to increase the channel number, or rotate the knob anti-clockwise to decrease the channel number, while enable all tone alert ,handover channel will hear a channel number.

Note: If a channel is not programmed, the display appears Un-programmed Channel and prompt no channel, LED indicator flash red.

Selecting a Zone

The radio supports up to 32 zones, each with a maximum of 16 channels, 32 zones all support up to 160 channels. Via the programming software you can select 2 desire zones at most to write in. You may select a desire zone through by setting zone toggle function to button 1 or button 2, then handover zone. While enable all tone alert, select zone will hear a zone number and channel number.

Dual Modes Switching

If current channel mode is D/A compatible, press side button AD Switch function to switch the channel mode. The current channel mode is digital compatible analog , press AD Switch button to switch to analog compatible digital mode; the current channel mode is analog compatible digital, press AD Switch button to switch to digital compatible analog mode.

Note: AD Switch function only switching the channel mode temporarily, while you restart the radio or rotate channel selector knob, the current channel will resume to default mode.

Call

Each digital channel may preset a contact, the preset contact could be a private call contact, a group call contact or an all call contact; on analog channel press and hold down the PTT key to transmit. On digital compatible analog channel press PTT key, if is not within hang time to transmit analog call, within the preset time period to call back; On analog compatible digital channel press PTT key, if is not within hang time to transmit digital call, within the preset time period to call back; To transmit press and hold down the PTT key, LED indication glows red, speak into the microphone, hold the palm microphone approximately 3 to 4 centimeters away from your mouth.

Note: While enable talk permit indication feature, if the channel available, press PTT key to transmit will with a tone.

1. Private Call

If the feature “private call ACK” is enabled, to transmit a private call need to confirm whether it is power on or activate on the current channel.

- If you preset a private call contact for current digital channel. Press PTT key to transmit a private call;
- You can set the One Touch Call key as private call feature, then press programmed key to transmit a private call.

2. Group Call

- If you preset a group call contact for current digital channel. Press PTT key to transmit a group call;
- You can set the One Touch Call key as group call feature, then press programmed key to transmit a group call.

3. All Call

- If you preset an all call contact for current digital channel. Press PTT key to transmit an all call;

Receiving and responding to a call





On digital channel, while a private call is received, you may press the PTT key within the preset time period to call back. If you do not respond to a received private call within the preset time period, the radio will display the missed call icon; while a group call is received, you may press the PTT key within the preset time period to call back. If you do not respond to a received group call within the preset time period, the radio will display the missed call icon; while an all call is received, you can't respond to an all call.

Note: While enable channel free indication feature, if the transmitter release PTT key will with a tone.

Button Setting

For enhanced convenience, you may program the keys button1, button2, short and Long press of a key can be assigned with different functions.

Programmable keys are including functions listed below, icon  indicates functions that are available on analog mode.

No.	Shortcut Keys	Description
1	Unassigned	Not assigned with any function
2	On Touch Call 1-6 	Quick transmit group call/ private call/call alert or preset SMS
3	Emergency On 	To send emergency information, only set short press on orange button
4	Emergency Off 	To exit emergency mode, only set long
5	Monitor	press on orange button
6	Scan On/Off	To enable or disable monitor function
7	All Alert Tones On/Off	To enable or disable scan function quickly
8	Battery Indication	To enable or disable all tones quickly It' s convenient to know battery capacity. If battery strength level is 70%-100%, a Power High sound; if battery strength level is 30%-70%, a Power Middle sound; if battery strength level is 15%-30%, a Power Low sound.
9	Zone Toggle	Quick access to Zone Toggle
10	Priority Interrupt 	To interrupt activity of current channel forcibly
11	AD Switch	To temporarily switch channel mode to AD or DA
12	Flashlight On/Off	To enable or disable flashlight quickly
13	High/Low Power	To switch High/Low Power quickly
14	Repeater/Talkaround	To enable or disable talk around quickly
15	Vox On/Off	To enable or disable VOX quickly
16	Nuisance Delete	To temporarily ignore unwanted channel activity
16	Permanent Monitor	To enable or disable permanent monitor function

Functions and Operations

Voice Encryption

The voice encryption can encrypt your audio signals to guarantee the privacy of your communication, via the programming software user can select encryption type as static or dynamic. If the encrypt feature is enabled, the transmitter and receiver will be set as the same encryption type and same encryption key, otherwise the receiver is mute.

Via programmable software to set it: General Settings folder →Voice Encryption Type→ Voice Encryption Key

Note: This feature is effective on digital channel, if enable voice encryption feature, the voice encryption key must be 10 characters, there are including letters and numbers.

VOX

If enable VOX feature you can enjoy hands-free communication, the radio will automatically begin transmitting when you speaking, and terminate transmitting when you stop talking with no need of PTT press. You may set VOX level as 1~8 or disable (Off). When the environment too much noise, VOX level will be higher, when the environment is quiet, VOX level will be lower. It allow user to set VOX delay as 500 to 10000 milliseconds. If the VOX level is set as off via the programming software, press programmed VOX on/off key can't enable VOX feature, if the VOX level is set as 1 to 8, press programmed VOX on/off key can enable or disable VOX feature

Via programmable software to set it: General Settings folder →VOX level→ VOX delay(ms)

Note: The VOX feature shall work with a dedicated earpiece.

Battery Saver

This function allows an idler radio to automatically enter battery saver mode, the mode will extend battery service life, but response time may be delayed. You can set battery saver time ratio as : 1:1 1:2 1:3 1:4, the time rate is smaller, the power saving more evidently.

Via programmable software to set it: General Setting folder→Battery Saver

Warning Tones

Voice Indication

If enable voice indication feature, the radio will give tone indication for channel change, zone change, power level switch, scan feature enable or disable, VOX on or off, low battery alert, repeater mode or talk around mode switch and etc.

Channel Free Indication

On digital mode, if enable Channel Free Indication feature, the receiver gives a high-pitched tone indication while the transmitter release PTT key to stop transmitting.

Talk Permit Indication

There are four options are available for Talk Permit Indication feature: None (the radio does not give any tone indication for transmission on analog and digital channel), Analog (the radio gives tone indication for transmission on analog channel), Analog& Digital (the radio gives tone indication for transmission on analog and digital channel), Digital (the radio gives tone indication for transmission on digital channel).

Via programmable software to set it: General Settings folder → Tone Alerts → Voice Indication → Channel Free Indication → Talk Permit Indication

Reject Stranger Call

On digital mode, if enable reject strange call feature, while the call ID not exist in the contacts list, it's unable to transmit or receive. When received group call or all call, the device ID of transmitter and group call ID or all call ID preset on address list.

Via programmable software to set it: General Settings folder → Reject Strange Call

Low Battery Warning

When your battery gets low, LED indicator glows red and with a warning tone: “Please Charge” please replace the battery or charge the battery in time. The radio will turn off automatically while battery is too low.

Via programmable software to set it: General Setting folder→RX low battery internal

Digital Emergency

In case of an emergency you can enter emergency mode to ask for help, short press programmed “Emergency on” key to send emergency information, To exit emergency mode, long press “Emergency off”. On regular type alarm, after send emergency information then receive ACK command or the alarm cycles expire, the radio will exit the emergency mode automatically. On silent type alarm, after send emergency information then press PTT key to exit emergency mode.

Via programmable software to set it: Signaling Systems folder → Digital Red Alert → add system1 to set parameters → Channel folder → add Emergency system

- **Emergency Type:** Disable, Regular, Silent, Silent with voice, the Disable option is unable to transmit emergency information.
- **Emergency Mode:** Emergency Alarm, emergency alarm with call, emergency alarm with voice to follow.
- **Revert Channel:** Revert channel is used for digital emergency, only the channel default address is set as group call contact, the channel is available for revert channel.
- **Impolite Retries:** If the current channel is busy, press programmed key also can send emergency information, number of impolite retries can be set as 1 to 15.
- **Polite Retries:** Only when the current channel is free, press programmed key to send emergency information, number of polite retries can be set as 0 to 14 and endless.
- **Hot MIC Duration:** If the emergency mode set as emergency alarm with voice to follow, after send emergency information, you voice and background noise to be transmitted automatically as you don't need to press PTT key within hot MIC duration.

Note: while the short press is set as emergency on, the long press will be set as emergency off default.

Scan

Scan is useful for monitoring signals on the radio channels, the channels include in the scan list. While scanning, the radio checks for a signal on each channel and only stops on a channel if a signal is present. Press programmed Scan on/off key to begin scanning, while scanning on, a “scan on” sounds, LED indicator flash red. While scanning off, a “scan off” sounds

Via programmable software to set it: Scan folder(Scan hang time) → A desired scan list → add available channel to members channel → a digital or analog channel to select scan list

- **Scan Hang Time** : When a signal is detected on a channel, scan pauses on that channel, the radio will remain on the busy channel until the signal is no longer present. When the signal “ drop out” the radio will remain on the channel momentarily before scan resumes. The delay time is programmed 500 to 10000 milliseconds.
- **Talkback** : When a signal is detected on a channel, scan pauses on that channel, press PTT key can talk back on the channel if enable “Talk Back’ feature; if “Talk Back” isn’t checked, press PTT key may talk back on the designated channel.
- **TX Designated Channel** : During scanning, Press PTT key will transmit on TX designated channel. You can set TX Designated Channel as Last Active Channel, Selected channel or a desired channel from scan list.

Auto Scan

If Auto Scan feature is enabled for a channel, the radio will automatically enter scan mode when it is switched to this channel. To stop scanning, press programmed Scan On/Off key or switch to other channels. If return to the channel will enter scan mode directly.

Monitor and Permanent Monitor

Monitor: On analog or digital channel, enable the Monitor feature to monitor current channel activities and receive weak signals. Press the programmed Monitor key to activate the monitor function, if a signal is detected, until the signal is no longer present the radio will exit monitor mode.

Permanent Monitor: Permanent monitor feature is the same as monitor, but long press the Permanent Monitor key to enter monitor mode, the radio will remain on monitor mode until long press it again to exit.

Message

On digital channel, you can send preset messages by programmed one touch call key. Edit message text via programming software, the message list save up to 10 entries, and each of a message contains 140 characters at most

One Touch Call

On digital channel, one touch call feature contains: to send messages or transmit to a group call contact, to send messages or send call alert and transmit to a private call contact.

● Group Call

On one touch call menu, the call member select group call contact, and the call type select group call. Then the programmed key set as one touch call, press the programmed key a high-pitched tone sound, with 5 seconds press PTT key to transmit a group call.

● Group Message

On one touch call menu, the call member select group call contact, and the call type select short message, message text select from preset message list. Then the programmed key set as one touch call, press the programmed key to send a message to a group call.

● Private Call

On one touch call menu, the call member select private call contact, and the call type select private call. Then the programmed key set as one touch call, press the programmed key a high-pitched tone sound, with 5 seconds press PTT key to transmit a private call.

● Private Message

On one touch call menu, the call member select private call contact, and the call type select short message, message text select from preset message list. Then the programmed key set as one touch call, press the programmed key to send a message to a private call.

● Call Alert

On one touch call menu, the call member select private call contact, and the call type select call alert, then the programmed key set as one touch call, press the programmed key to send call alert to a private call.

Talk Around

Talk Around: When your repeater malfunctions, or when radio is out of repeater's range, you can continue to communicate in talk around mode. While enable talk around feature, by this time TX frequency the same as to RX frequency. Press the programmed Repeater/Talk Around key to switch between repeater modes and talk around mode. Switch to talk around, a "talk around" sound; switch to repeater mode, a "repeater" sounds.

Via programmable software to set it: Channel folder → Zone → a digital or analog channel → Allow Talk Around

Note To enable this function, TX frequency should be different from RX frequency, and the channel will set as allow talk around on the programming software.

TX Power

You can switch power levels to Low or High. If you communicate with radio located at a distant place please select High power; if you communicate with radio located at a close place please select Low power to save battery. Press the programmed High/Low Power key to switch between high power and low power. Switch to high power, a "high power" sounds; switch to low power, a "low power" sounds.

Press programmed High/Low power key to switch power level or select power level via programming software

Via programmable software to set it: Channel folder → Zone → a digital or analog channel → TX Parameters → Power Level

Bandwidth

On analog mode, there are two types of bandwidth available, you can choose bandwidth as wide (25 KHz) or narrow (12.5 kHz) via programming software.

Via programmable software to set it: Channel folder → Zone → An analog channel → Bandwidth

Squelch Level

On analog mode, this feature allows you to adjust the squelch threshold for the radio to receive audio. You can set squelch level as 0~9. High level requires stronger signal for the radio to un-mute.

Via programmable software to set it: Channel folder → Zone → an analog channel → Squelch Level

Time Out Timer (TOT)

The purpose of TOT is to prevent any user occupy a channel for an extended period. If a channel is busy, the time will be shorter. If the preset time expires, the radio will generate beep and terminate transmission automatically. Via programming software, you can set TOT as 15-495 second.

Via programmable software to set it: Channels folder → Zone → A digital or analog channel → TX Parameters → TOT-TOT Rekey Delay

TX Permission

Digital Channel

This feature can restrict the channel if it is already in use you will be unable to transmit. There are three options available: always, color code free, channel free, if choose always, whenever press PTT key to transmit directly; If choose color code free, you will be unable to transmit on the channel if the color code is already in use; If choose channel free, you will be unable to transmit on the channel if it is already in use. If the channel is busy, press PTT key a warning tone will sound.

Via programmable software to set it: Channels folder→Zone→a digital channel→TX Parameters→Admit Criteria

Analog Channel

This feature can restrict the channel if it is already in use you will be unable to transmit. There are three options available: off, carrier, CTCSS/CDCSS, if choose Off, whenever press PTT key to transmit directly; If choose carrier, you will be unable to transmit on the channel if the channel is being used by others; If choose CTCSS/CDCSS, you will be unable to transmit on the channel if it is already in use and the CTCSS/CDCSS code in use. If the channel is busy, press PTT key a warning tone will sound.

Via programmable software to set it: Channels folder→Zone→a analog channel→TX Parameters→BCL

CTCSS/CDCSS

On analog channel, you can set unique CTCSS/CDCSS to guarantee the privacy of your communication, on digital compatible analog channel or analog compatible digital channel, is must attach to CTCSS/CDCSS. If CTCSS/CDCSS has been set on the current channel, CTCSS/CDCSS match is required for the radio to receive an incoming signal. You can select a CTCSS/CDCSS from CTCSS standard frequency table or CDCSS standard code table.

Via programmable software to set it: Channels folder→Zone→a analog channel→TX Parameters to select encode→RX Parameters to select decode

- **Decode:** Only when receiver receives a call containing matching the decode, you can hear the call;
- **Encode:** Signal that you transmit will only be heard by parties whose CTCSS/CDCSS signaling matches your transceiver.

Note The radio approve of non-standard code, on analog mode, you can input non-standard code as you need.

Dual Capacity Direct Mode

If enable TDMA direct mode, the members in the same group call must use the same slot, one frequency supports calls in two slots synchronously in order to avoid interfering communications in the other slot.

Via programmable software to set it: Channels folder→Zone→a digital channel or A/D Channel→TDMA Bypass Mode→Slot Align→Slot→Pseudo Trunk TX Slot

Note: This function is available only in digital operation.

Radio Priority-Based Interrupt

The call priority feature allows you to interrupt the on-going call on current forcibly, a preemptive call can interrupt other on-going calls with lower priority to release the channel for itself. There are 5 voice priorities available, level 0 is lower, level 3 is higher, and emergency call is the highest. To transmit the Priority Interrupt command also can press the programmed [Priority Interrupt] key, in order to make the channel free for new call or message transmission.

Via programmable software to set it: Channels folder→Zone→a digital channel or A/D Channel→Priority Interrupt→Voice Priority

Note: This function is available only in digital operation.

Alone Worker

This function is useful for persons who work lonely and encounter an incident; you cannot press any keys or transmit audio within the preset period time. The radio will alarm automatically to ask help. Via the programming software to enable the feature, and setting work alone response time, work alone warn time, work alone response operation.

Via programmable software to set it: Signaling Systems folder→Work Alone→Work Alone Enable→Work Alone Response Time→Work Alone Warn Time→Work Alone Response Operation

CTCSS Frequency Table

CTCSS No.	Freq. [Hz]	CTCSS No.	Freq. [Hz]	CTCSS No.	Freq. [Hz]	CTCSS No.	Freq. [Hz]
1	62.5	14	100.0	27	156.7	40	196.6
2	67.0	15	103.5	28	159.8	41	199.5
3	69.3	16	107.2	29	162.2	42	203.5
4	71.9	17	110.9	30	165.5	43	206.5
5	74.4	18	114.8	31	167.9	44	210.7
6	77.0	19	118.8	32	171.3	45	218.1
7	79.7	20	123.0	33	173.8	46	225.7
8	82.5	21	127.3	34	177.3	47	229.1
9	85.4	22	131.8	35	179.9	48	233.6
10	88.5	23	136.5	36	183.5	49	241.8
11	91.5	24	141.3	37	186.2	50	250.3
12	94.8	25	146.2	38	189.9	51	254.1
13	97.4	26	151.4	39	192.8		

Note: On the table, thirty-nine standard CTCSS/CDCSS code of analog channel, twelve bold fonts are particular CTCSS/CDCSS code of compatible channel.

CDCSS Standard Code Table

CDCSS NO.	Positive Code	Negative Code	CDCSS NO.	Positive Code	Negative Code	CDCSS NO.	Positive Code	Negative Code
1	D023N	D023I	29	D174N	D174I	57	D445N	D445I
2	D025N	D025I	30	D205N	D205I	58	D464N	D464N
3	D026N	D026I	31	D223N	D223I	59	D465N	D465N
4	D031N	D031I	32	D226N	D226I	60	D466N	D466I
5	D032N	D032I	33	D243N	D243I	61	D503N	D503I
6	D043N	D043I	34	D244N	D244I	62	D506N	D506I
7	D047N	D047I	35	D245N	D245I	63	D516N	D516I
8	D051N	D051I	36	D251N	D251I	64	D532N	D532I
9	D054N	D054I	37	D261N	D261I	65	D546N	D546I
10	D065N	D065I	38	D263N	D263I	66	D565N	D565I
11	D071N	D071I	39	D265N	D265I	67	D606N	D606I
12	D072N	D072I	40	D271N	D271I	68	D612N	D612I
13	D073N	D073I	41	D306N	D306I	69	D624N	D624I
14	D074N	D074I	42	D311N	D311I	70	D627N	D627I
15	D114N	D114I	43	D315N	D315I	71	D631N	D631I
16	D115N	D115I	44	D331N	D331I	72	D632N	D632I
17	D116N	D116I	45	D343N	D343I	73	D654N	D654I
18	D125N	D125I	46	D346N	D346I	74	D662N	D662I
19	D131N	D131I	47	D351N	D351I	75	D664N	D664I
20	D132N	D132I	48	D364N	D364I	76	D703N	D703I
21	D134N	D134I	49	D365N	D365I	77	D712N	D712I
22	D143N	D143I	50	D371N	D371I	78	D723N	D723I
23	D152N	D152I	51	D411N	D411I	79	D731N	D731N
24	D155N	D155I	52	D412N	D412I	80	D732N	D732N
25	D156N	D156I	53	D413N	D413I	81	D734N	D734I
26	D162N	D162I	54	D423N	D423I	82	D743N	D743I
27	D165N	D165I	55	D431N	D431I	83	D754N	D754I
28	D172N	D172I	56	D432N	D432I			

Specifications

General	
Frequency range	446.0-446.2MHz
Channel Capacity	160
Zones	32
Channel Spacing	12.5KHz/25KHz
Operating Voltage	DC 7.4V (±20%)
Battery Capacity	2000 mAh
Battery Life (5/5/90)	Digital 22 Hours Analog 16 Hours
Recording Time	400 Hours
Frequency Stability	±1.5ppm
Antenna Impedance	50Ω
Dimensions (L×W×H)	57 (L) * 32(W)* 119 (H)mm
Weight	239g(Including Battery)
Transmitter	
RF Output Power	0.5W
4FSK Modulation	12.5kHz Only data : 7K60FXD 12.5kHz data and audio : 7K60FXE
FM Modulation	12.5 kHz : 8K50F3E ; 25 kHz : 16KΦF3E ;
Modulation Limiting	+/- 2.5kHz @ 12.5kHz; +/- 5kHz @ 25kHz
FM Noise	-40dB
Conducted Emission	-36 dBm≤1GHz/-30 dBm≥1GHz
Adjacent Channel Power	≤-60dB
Audio Response	+1/-3 dB
Audio Distortion	3%
Digital Voice coder Type	AMBE3000
Receiver	
Digital Sensitivity	5% BER : 0.25 uV
Analog Sensitivity	0.25 uV (12 dB SINAD)
Intermodulation	60dB
Adjacent Channel Selectivity	60 dB
Spurious Response Rejection	60 dB
FM Noise	-40dB
Audio Response	+1/-3 dB
Audio output power	1.5W
Audio Distortion	3% (Typical)
Conducted Spurious Emission	-57dBm
GPS Accuracy	Horizontal Accuracy≤-10m
TTFF (Time To First Fix) Cold Start	(with well signal)
TTFF (Time To First Fix) Hot Start	< 1 Minute (with well signal)

Environmental Specifications	
Working Temperature	-20°C—+60°C
Storage Temperature	-30°C—+85°C
Humidity	MIL-STD-810C/D/E/F Standard
Vibration & Shock	MIL-STD-810C/D/E/F Standard
Dustproof & waterproof	IP68

Statement

This manual is deemed to be compiled to be accurate and complete. For any doubt, please contact us. We will give you professional answers. As radio communication technologies develop rapidly, BelFone reserves the right to change product design and specification without prior notice.

ATTENTION: Conditions of use!

The band of frequencies on which this device operates is administrated by limitations and/or permissions for their usage. Consequently, in the EU countries mentioned in the sheet, operators must consult the entrusted authorities. In particular, they must possess a license or a frequency assigned to them by their competent authority.

ACHTUNG: Informativ zur Benutzung!

Das Frequenzband, auf dem dieses Gerät arbeitet, wird durch Einschränkungen und/oder Berechtigungen für deren Verwendung verwaltet. Folglich müssen die Betreiber in den in der Tabelle aufgeführten EU-Ländern die zuständigen Behörden konsultieren. Insbesondere müssen sie über eine Lizenz verfügen, oder eine Frequenz besitzen, die ihnen von ihrer jeweiligen zuständigen Behörde zugewiesen wurde.

ATTENTION: conditions d'utilisation!

Certaines bandes de fréquence sur lesquelles cet appareil fonctionne sont régies par des limitations et/ou il faut des autorisations pour les utiliser. Par conséquent, dans les pays de l'UE indiqués dans le tableau, les opérateurs doivent d'abord consulter les autorités appropriées. Les opérateurs utilisant cet appareil doivent posséder une licence ou une fréquence qui leur est attribuée par les autorités compétentes.

ATENCIÓN : información sobre el uso!

La banda de frecuencias en la que opera este aparato está gestionada por limitaciones y/o permisos para su uso. Por lo tanto, en los países de la UE que se muestran en la tabla, los operadores deben consultar a las autoridades correspondientes. En particular, deben poseer una licencia o una frecuencia asignada por su respectiva autoridad competente.

ATTENZIONE: informativa all'uso!

La banda delle frequenze sulle quali opera questo apparato è amministrata da limitazioni e/o permessi al loro uso. Quindi, nei paese UE riportati nella tabella, gli operatori devono consultare le autorità preposte. Segnatamente, devono possedere una licenza oppure una frequenza assegnata a loro dalla rispettiva autorità competente.

					
AT	BE	BG	CY	CZ	DE
DK	ES	EE	FI	FR	UK
EL	HR	HU	IE	IT	LT
LU	LV	MT	NL	PL	PT
RO	SK	SI	SE	CH	IS
LI	NO	-	-	-	-



Default Programming at Factory

Analogue Channels			
RX/TX Channels			Sub Audio Dec/En
Chn	Pri	Frequency	Code No. (Value)
1	-	CH1 (446.00625)	No. 15 (D-114 N)
2	-	CH2 (446.01875)	No. 16 (D-115 N)
3	-	CH3 (446.03125)	No. 1 (D-023 N)
4	-	CH4 (446.04375)	No. 2 (D-025 N)
5	-	CH5 (446.05625)	No. 3 (D-026 N)
6	-	CH6 (446.06875)	No. 11 (D-071 N)
7	-	CH7 (446.08125)	No. 12 (D-072 N)
8	-	CH8 (446.09375)	No. 13 (D-073 N)
9	-	CH1 (446.00625)	No. 23 (D-152 N)
10	-	CH2 (446.01875)	No. 24 (D-155 N)
11	-	CH3 (446.03125)	No. 25 (D-156 N)
12	-	CH4 (446.04375)	No. 26 (D-162 N)
13	-	CH5 (446.05625)	No. 27 (D-165 N)
14	-	CH6 (446.06875)	No. 30 (D-205 N)
15	-	CH7 (446.08125)	No. 32 (D-226 N)
16	-	CH8 (446.09375)	No. 31 (D-223 N)

Digital Channels			
Zone	Channel Name	Frequency (Mhz)	Codes
1	CHAN 1	446.103125	Color Code – 1
1	CHAN 2	446.109375	Color Code – 2
1	CHAN 3	446.115625	Color Code – 3
1	CHAN 4	446.121875	Color Code – 4
1	CHAN 5	446.128125	Color Code – 5
1	CHAN 6	446.134375	Color Code – 6
1	CHAN 7	446.140625	Color Code – 7
1	CHAN 8	446.146875	Color Code – 8
1	CHAN 9	446.153125	Color Code – 9
1	CHAN 10	446.159375	Color Code – 10
1	CHAN 11	446.165625	Color Code – 11
1	CHAN 12	446.171875	Color Code – 12
1	CHAN 13	446.178125	Color Code – 13
1	CHAN 14	446.184375	Color Code – 14
1	CHAN 15	446.190625	Color Code – 15
1	CHAN 16	446.196875	Color Code - 0

EU Declaration of Conformity

In accordance with EU Directives and Regulations



Fujian Belfone Communications Technology CO.,Ltd

A-15, Huaqiao Economic Development Zone, Shuangyang,
Luojiang, Quanzhou, Fujian, China 362000

as the manufacturer hereby declares under our sole responsibility that the,

Product(s): Digital license free Radio

Model name: BF-TD510PMR,BF-TD510LF

is in conformity with the essential requirements of the RE Directive 2014/53/EU:

Radio

Article 3.2 EN303 405 V1.1.1

EMC Draft ETSI EN 301 489-1 V2,2,0

Article 3.1(b) Draft ETSI EN 301 489-5 V2,2,0

Safety EN 60950-1:2006/A11:2009/A1:2010/A12:2011/A2:2013

Article 3.1(a)

Health EN 50566:2017

Article 3.1(a) EN62209-2:2010

The essential radio test suites, as defined in the quoted standards have been performed.

The notified body Most Technology Service Co., Limited (EU Identification Number: 0700) performed a conformity assessment according to Annex III, Module B.

Year of first application of CE mark: 2019

Signed on behalf of Fujian Belfone Communications Technology CO., Ltd

A handwritten signature in black ink, appearing to be "李丽清" (Li Liqing), written over a horizontal line.

(Signature of authorized person)

Name: 李丽清

Title: Vice President

Date: Apr 10th, 2019

Belfone

FUJIAN BELFONE COMMUNICATIONS TECHNOLOGY CO.,LTD.

Add: A-15 Huaqiao Economic Development Zone,
Shuangyang, Luojiang, Quanzhou, Fujian, China

Tel: +86 595 28396717

Fax: +86 595 22771635

Email: overseas@belfone.com

Website: www.belfone.com

Copyright © 2020 by Atlas Communications SA, Switzerland
www.atlas-communications.ch

We reserve the right to decline any responsibility
sourced by errors of definitions,
formulations and incorrect data

