

BelFone

www.belfone.com

BelFone

BF-TD515

Digital FM Transceiver Model

Notice to the user

Government law prohibits the operation of unlicensed radio transmitters within the territories under government control.

Illegal operation is punishable by fine or imprisonment or both.

THANK YOU!

We are grateful you choose BelFone series professional radio communications products!

Since 1989, BelFone has been always engaging in research and exploration of radio communications technologies, in order to lead intelligent technologies in the industry. We still make every effort to research and design products according to modern complicated communications environment, and we offer complete and customized communication solutions to clients. Our products will satisfy you because of its excellent performance and outstanding communications strength. No matter what field you are in. You will be satisfied with the radio.

This manual is applicable to

VHF/UHF digital FM transceiver model: BF-TD515

Warning!

- ◆ In explosive atmospheres(inflammable gas, dust particles, much powder area, etc.),please turn the power off.

Precautions

It's important that the operator is aware of and understands hazards common to the operation of any radio .Please observe the following safety precautions to prevent radio damage or personal injury. The following precautions shall be observed during operation, service and repair of this radio.

- ◆ The recommended usage rate is 1 minute for TX and 4 minutes for RX, when the radio is used for transmission for many hours continuously, the radiator and chassis will become hot, allow the rear panel of the radio to contact surface of low melting point /low Ignition point object;
- ◆ Don't leave the transceiver in direct sunlight for a long time, don't place the transceiver on extremely heat, damp, dusty area, and don't put it on unstable surfaces;
- ◆ When restriction or warnings are posted regarding the use of radio devices, please obey the regulation turn the transceiver power off;
- ◆ Use of the radio while you are driving may be against traffic laws, please prohibit using it ;
- ◆ If you notice any problems on the radio, please turn off at first. Then contact with local dealer. Do not modify this radio unless instructed by this manual or refer service to a qualified licensed or certified technician only;
- ◆ If you want to use the machine for secondary development, please contact with BelFone's technical engineer or dealer for technical assistance;
- ◆ Please keep the surface of radio is clean and dry, clean the radio using a cloth moistened with clean water and a mild dishwashing liquid.

CONTENTS

Supplied Accessories	01
Getting Acquainted	06
Basic Operation	07
LCD Icons	07
Turning the Power On /Off	08
Adjusting the volume	08
Selecting a Channel	08
Selecting a Zone	08
Dual Modes Switching	09
Call	09
Button Setting	10
Functions and Operations	12
Contacts	12
Scan	13
Zone	14
SMS	14
Call Logs	14
Settings	15
Emergency	16
Work Alone	17
Monitor and Permanent Monitor	17
Voice Encryption	18
Battery Saver	18
Reject Stranger Call	18
Tone Alerts	19
Lowery Battery Alert	19
Time-Out-Timer (TOT)	19
TX Permission	20
Analog Mode	20
Bandwidth	20
CTCSS/CDCSS	21
CTCSS Standard Frequency Table	22
CDCSS Standard Code Table	23
Specifications	24
Statement	25

Supplied Accessories

Notes: The accessories listed below are covered by BelFone dealer, authorized BelFone agents or factories .

After carefully unpacking the transceiver, identify the items listed in the table below. If any items are missing or have been damaged during shipment please contact with dealer immediately.

Accessories

Items	Quantity
Antenna	1
Strap	1
Belt Clip	1
Charger	1
Li-ion Battery	1
Screws	1
User Manual	1
Warranty Card	1
Certificate	1

Antenna

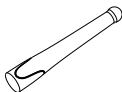

Strap



Charger



Li-ion Battery



Belt Clip

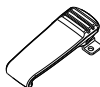

Screws



Installation of Accessories

Installation/ Removing the Antenna

Hold the supplied antenna by its base, then screw it into the connector on the top panel of the radio until fasten.

Turn the antenna anti-clockwise to remove it.

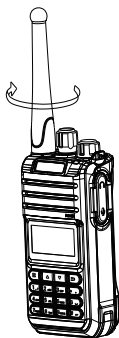

Installation/ Removing the Belt Clip

Attach the belt clip using the two supplied 3*7mm binding screws.

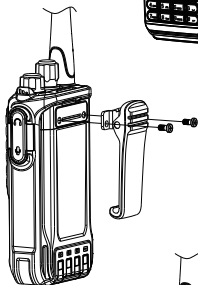

Attaching/Removing the Strap

Thread the hand strap to the loop back of your two-way radio.

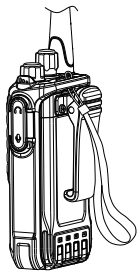

Attaching/Removing the Battery

Warning!

- Don't short-circuit the battery, it may cause the battery damaged or burst into flame;
- Never attempt to remove the casing from battery, that avoid to short the battery terminal;
- Battery is flammable objects, don't throw it into fire or don't use it on dangerous area.

Match the guides of the battery with the corresponding grooves on the upper rear of the radio, then press the battery until a click is heard to lock it in place.

To remove the battery, please turn the power off then press the release latch to unlock the battery pull the battery away from the radio.

Note: Don't attach / remove the battery if the transceiver turned on.

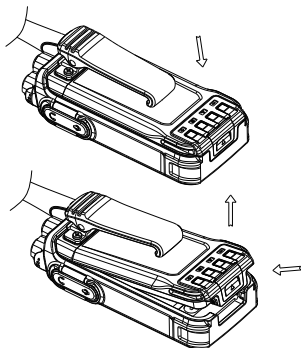

Battery Information

New battery is shipped not fully charged from the factory, please charge your battery before using it, charging a new battery for 5 hours before initial use. The maximum battery capacity and performance is achieved after three full charge/discharge cycles. If you notice the battery power runs lows, please recharge the battery.

Applicable Battery

To reduce the risk of injury, please only use the battery and charger specified by Be!Fone, other batteries may burst, causing bodily injury and property damage.

Battery Tips

- When charging your battery, keep it at a temperature among 5°C-40°C. Temperature out of the limit may cause battery leakage or damage.
- When charging a battery attached to a radio, turn the radio off to ensure a full charge.
- Do not cut off the power supply or remove the battery when charging a battery.
- Never charge a battery that is wet, please dry it with soft cloth prior to charge.
- Even if the battery is full charged, the operating time is noticeably shorter than normal performance; it is time to buy a new battery.

To Prolong Battery Life

1. Battery performance will be greatly decreased at a temperature below 0°C , a spare battery is necessary in cold weather, the cold battery unable to work in this situation may work under room temperature, so keep it for later use.
2. The dust on the battery contact may cause battery breakdown, please use a clean dry cloth to wipe it before attaching the battery to the radio.

Battery Storage

1. Fully charge a battery before you store it for a long time, to avoid battery damage due to over-discharge.
2. Recharge a battery after several months' storage, to avoid battery capacity reduction due to over-discharge. (NI-MH batteries: 3 months, Li-Ion& Li-polymer batteries: 6 months)
3. Store your battery in a cool, dry place under room temperature, to reduce self-discharge.

Charging the Battery

Use only the charger specified by the manufacturer, the charge indicator indicates the charging progress.

Charger Status	Charger Indicator
Standby(No-load)	Charge Indicator glows green
Battery is charging	Charge Indicator glows red
Battery is fully charged	Charge Indicator glows green

Charging Steps:

1. Plug the AC connector of the switching power into the AC outlet socket.
2. Place the battery or the radio is attached with a battery in the charger.
3. Making sure the battery is connected to the charger, the charging process initiates when the charger indicator glows red.
4. The charger indicator glows green when the battery is fully charged, please remove the battery then.

Note: While charging the temperature out of the limit the LED indicator of charger will not light; if battery has damaged or battery is not connected to the charger correctly, The LED indicator of charger also will not light.

Attaching the Speaker/Microphone

Open the accessory port cover, then align the plug with the accessory port and tighten the screw on the plug.

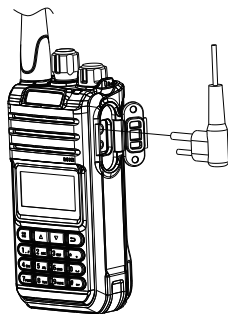

Getting Acquainted

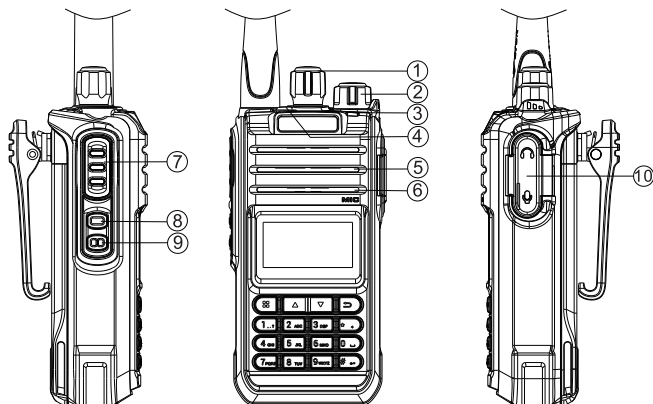

① Channel Selector Knob

Turn the knob to select channel 1-16.

② Power Switch/Volume Adjust Keys

Turn clockwise to switch the radio power on, when the radio is turned on, rotate clockwise to increased volume, counter-clockwise to decrease the volume. Turn counterclockwise fully to switch the radio off.

③ LED Indicator

When transmitting LED glows red, when receiving LED glows green; when un-programmed LED flashes red; when scanning LED flashes red.

④ Orange Button

Press to activate the programmable function. (The detailed consult to basic operation)

⑤ Speaker

⑥ MIC

⑦ PTT Key

Press and hold down the PTT key then speak into the microphone to transmit.

⑧ Button 1

Press to activate the programmable function. (The detailed consult to basic operation)

⑨ Button 2























Press to activate the programmable function. (The detailed consult to basic operation)

⑩ MIC-SP-USB Jack

Connect to optional speaker/MIC and USB programming cable.

Basic Operation

LCD Icons

	Signal Strength		Inbox Full
	High/Low Power		Message send successfully
	Digital Mode		Message send Failed
	Analog Mode		Read Message Inbox
	Analog compatible digital		Unread Message Inbox
	Digital compatible analog		Emergency On
	Private Call		Keypad Locked
	Group Call		Direct /Talk around Mode
	All Call		Monitoring/Permanent Monitoring
	Scanning On		Disable All Tone Alert
	Unread message		Battery Capacity

Turning the Power On /Off

Rotate the power switch/volume adjusting keys clockwise to turn the power on.

Rotate the power switch/volume adjusting keys anti-clockwise to turn the power off.

Note: If you active power on password function via program software ,each time you turn on transceiver, must be enter 6 digit password, while occur password error, the transceiver will restart automatically and then input password again . When 3 times wrong in input password continuously, after it transceiver must be kill, only reprogram it then device work normal. Please enable power on password with due care.

Adjusting the Volume

After the radio is power on, you can rotate the power switch/volume adjust keys to adjust the volume level, rotate the knob clockwise to increase the volume, or rotate the knob anti-clockwise to decrease the volume.

Selecting a Channel

Turn the channel selector knob to select channel 1 to 16, rotate the knob clockwise to increase the channel number, or rotate the knob anti-clockwise to decrease the channel number, while enable all tone alert ,handover channel will hear a channel number.

Note: If a channel is not programmed, LED indicator flash red and a prompt tone " no channel "sounds..

Selecting a Zone

The radio supports up to 64 zones, each with a maximum of 16 channels, 64 zones all support up to 1024 channels. You may select a desire zone through enter zone menu or setting zone selection function to orange button, button 1 or button 2, then handover zone. While enable all tone alert, select zone will hear a channel number.

Dual Modes Switching

If current channel mode is D/A compatible, press side button 【AD Switch】 function to switch the channel mode. The current channel mode is digital compatible analog , press 【AD Switch】 button to switch to analog compatible digital mode; the current channel mode is analog compatible digital, press 【AD Switch】 button to switch to digital compatible analog mode.

Note: AD Switch function only switching the channel mode temporarily, while you restart the radio or rotate channel selector knob, the current channel will resume to default mode.

Call

Each digital channel may preset a contact, the preset contact could be a private call contact, a group call contact or an all call contact; on analog channel press and hold down the PTT key to transmit. On digital compatible analog channel press PTT key, if is not within hang time to transmit analog call, within the preset time period to call back; On analog compatible digital channel press PTT key, if is not within hang time to transmit digital call, within the preset time period to call back; To transmit press and hold down the PTT key, LED indication glows red, speak into the microphone, hold the palm microphone approximately 3 to 4 centimeters away from your mouth.

Note: While enable talk permit indication feature, if the channel available, press PTT key to transmit will with a tone.

Private Call

If the feature “private call ACK” is enabled, to transmit a private call need to confirm whether it is power on or activate on the current channel.

- (1) If you preset a private call contact for current digital channel. Press PTT key to transmit a private call;
- (2) Enter Contacts menu to select the private call number you want to call, then press PTT key to transmit a private call;
- (3) Enter Contacts menu and go to manual dial menu or press programmed “Manual Dial” key, input a private call number you want to call, then press PTT key to transmit;
- (4) Enter Call Log menu to select the private call number you want to call, then press PTT key to transmit a private call;
- (5) You can set the One Touch Call key as private call feature, then press programmed key to transmit a private call.

Group Call

(1) If you preset a group call contact for current digital channel. Press PTT key to transmit a group call;

(2) Enter Contacts menu to select the group call number you want to call, then press PTT key to transmit a group call;

(3) Enter Call Log menu to select the group call number you want to call, then press PTT key to transmit a group call;

(4) You can set the One Touch Call key as group call feature, then press programmed key to transmit a group call.

All Call

(1) If you preset an all call contact for current digital channel. Press PTT key to transmit an all call;

(2) Enter Contacts menu to select the all call number you want to call, then press PTT key to transmit an all call;

(3) Enter Call Log menu to select the all call number you want to call, then press PTT key to transmit an all call;

Receiving and responding to a call

On digital channel, while a private call is received, you may press the PTT key within the preset time period to call back. If you do not respond to a received private call within the preset time period, the radio will display the missed call icon; while a group call is received, you may press the PTT key within the preset time period to call back. If you do not respond to a received group call within the preset time period, the radio will display the missed call icon; while an all call is received, you can't respond to an all call.

Note: While enable channel free indication feature, if the transmitter release PTT key will with a tone.

Button Setting

For enhanced convenience, you may program the keys button1, button2, short and Long press of a key can be assigned with different functions.

Programmable keys are including functions listed below, icon  indicates functions that are available on analog mode.

No.	Shortcut Keys	Description
1	Unassigned ~	Not assigned with any function
2	On Touch Call 1-6	Quick transmit group call/ private call/call alert or preset SMS
3	Emergency On	To send emergency information, only set short press on orange button
4	Emergency Off	To exit emergency mode, only set long press on orange button
5	Monitor ~	To enable or disable monitor function
6	Backlight Auto On/Off ~	Quick switch backlight mode
7	Keypad Lock ~	To lock or unlock the keypad quickly
8	Scan On/Off ~	To enable or disable scan function quickly
9	All Alert Tones On/Off ~	To enable or disable all tones quickly
10	Battery Indication ~	Quick view battery capacity
11	Short Message	Quick access to short message
12	Zone Toggle ~	Quick access to Zone Toggle
13	AD Switch	To temporarily switch channel mode to AD or DA
14	Address List	Quick access to Address List
15	Radio Enable	Quick access to Radio Enable
16	Radio Disable	Quick access to Radio Disable
17	Radio Check	Quick access to Radio Check
18	Remote Monitor	Quick access to Remote Monitor
19	High/Low Power ~	To switch High/Middle/Low Power quickly
20	Repeater/Talkaround ~	To enable or disable talk around quickly
21	Vox On/Off ~	To enable or disable VOX quickly
22	Nuisance Delete ~	To temporarily ignore unwanted channel activity
23	Permanent Monitor ~	To enable or disable permanent monitor function

Functions and Operations

Contacts

On the contacts, you can search address list members, add new contacts, manual dialing.

1. Group Call ()

While the contacts type as group call, you can select the menu to view its ID or send message.

2. Private Call ()

While select a contact as private call, a private call can view its ID、 send call alert 、 send message、 edit name or number 、 delete、 send device check、 disable or enable、 send remote monitor.

- **Call Alert:** Call alert is used for prompting the private receiver; ask them respond to transmitter if communication is available. While receiving call alert command the radio will generate alert tone.
- **Radio Check:** This function can check if the target radio is active in the system while don't send any tone alert to the target radio. When the radio is available, the screen displays: Radio check success, while the radio is unavailable, the screen displays: Answer time out.
- **Remote Monitor:** Allow a user to send a "Remote Monitor" request to the target device via menu. If the request is successful, you can enable the microphone of the target radio, and monitor its activities. Only the target radio is set remote monitor decode, that enable monitor its activities.
- **Remote Revive :** Allow a user to send " Remote revive " command to the target killed device, to allow it to be used normally.
- **Remote Kill:** Allow a user to send " Remote kill " command to the target device via menu. If the device is lost or stolen, a user can use this function to disable the device. However, this device will continue monitoring air interface to receive its " Remote revive " command.
- **Edit:** Modify the number or name of a private call contact. Press " * " key to delete, press "#" to switch input method, the available number range is 1~16776415, name input 16 characters at most.
- **Delete:** Delete unwanted contacts from the address list, if private call contact is set as channel default address or call number on one touch call, its unable to delete.

3. All Call ()

While the contacts type as all call, you can select the menu to view its ID or press PTT to call.

4. Manual Dial

You can manually input the private call number for calling or sending call alert , send message ,radio check, remote monitor , remote revive , remote kill.

5. New Contact

You can add a private call contact to the contact list. When input number, the available number range is 1~16776415, then edit name, press " * " key to delete, press "#" to switch input method, name input 16 characters at most. After add a private call contact successfully, on contacts list will show new contact.

Scan

1.Scan On/Off

While current channel add scan list and the list contain 2 channels at least, you may enable the feature. Scanning allows the device to search the scan list connected to the current channel to locate qualified channel for receiving or voicing. During scanning, the icon "  "appears, when activities are detected on a channel, the radio will stay on the channel to receive current activities. If you don't want to receive activities on the channel, press the programmed Nuisance Delete key to remove the channel from the scan list temporarily. To exit the scanning process, enter scan menu, switch channel or press the programmed Scan key.

Note:

If the channel enables the feature "Auto Scan" via the programming software, switch to the channel will enter scanning automatically;

2. View/Edit List



Allow a user to view/edit the scan list via menu, "View /edit list" allows a user to view the scan member, edit scan priority and delete a member from the scan list; Add scan channel allow a user to add a new member to the scan list, the list contain 16 channels at most. It is not allowed to create a new scan list or delete existing scan lists from the device. Digital and analog channel will be appear in the same scan list.

Zone

The radio supports up to 64 zones, each of zone supports 16 channels, totally 1024channels supported. Enter “Zone” menu to select a desired zone.

SMS

1. Inbox

The Inbox can save up to 50 received messages. Inbox the unread message displays: , read message displays: . For each message, you can choose to perform any of these operations: Reply, Forward and Delete.

2. Write



You can edit desired text message(140 characters at most) and send it to an private call contact or group call contact, when editing a message, press “#”key for switching input method, press “*” key for deletion and modification, press up or down key to switch input cursor. For non-numeric input method, key “1” is a symbol key. Key “0” is a space key. After the message is edited, you can select a contact from the address list which the message is sent to or manually dial a number to send to.

3. Preset SMS

Via programming software, user can save 10 entries text messages and each of a message contains 140 characters at most on preset SMS. You can choose to edit and send any entry.

Note: Preset text messages also can assign to one touch call, and press the programmed key to send messages.

4. Outbox

Enter outbox menu, you can view the message is sent successfully or failed, outbox can save up 50 sent messages. If sent message is successful displays , you can choose to forward , edit or delete it; If sent message is failed displays , you can choose to resend, forward , edit or delete.

Call Logs

1. Missed Call

The missed calls list can save up to 50 entries, when the memory for call logs is full, the oldest entry will be deleted automatically. You can add it to contact list or delete it.

2. Answered Calls

The answered calls list can save up to 50 entries, when the memory for call logs is full, the oldest entry will be deleted automatically. You can add it to contact list or delete it.

3. Outgoing Calls

The outgoing calls list can save up to 50 entries, when the memory for call logs is full, the oldest entry will be deleted automatically. You can add it to contact list or delete it.

Settings

1. Radio Setting

Allow a user to perform basic settings for the radio.

- **Display Contrast:** used to adjust the brightness of the screen. Press left key to reduce the contrast while pressing the right key to increase the contrast. Too high or too low contrast will make the screen fuzzy.
- **Tone/Indicator:** To set tones for your radio, include settings of all tones, SMS tone and keypad tone. If disable all tones, all alerts will be off except emergency tone.
- **TX Power:** Allow a user to change the power level, there are two levels available: high (indicated by H), middle (indicated by M) and lower (indicated by L).
- **Backlight:** To set the backlight parameters, you can select enable or disable, while you select enable, the light will become dark after 5 second you don't operate the key and the light will go out immediately while you select disable.
- **Boot Display:** Allow a user to enable or disable the boot screen via menu. If the Intro screen is enabled, while the radio power on, the screen display Belfone Logo and device name; while the Intro screen is disable, the screen only displays device name.
- **Keypad Lock:** Allow a user to enable or disable keypad lock via menu. While Keypad locked indicate: , that you can't operate the keypad except PTT key and orange button, button 1 or button 2. Press "MENU" and " #" key to unlock.
- **Language:** The radio supports two languages: Chinese and English.

● **LED indicator:** To set whether to enable LED indication via menu. While disable all indicator, the screen becomes dark and TX red indicator, Rx green indicator, scan orange indicator are off. Please use this function with due care.

● **Talk Around:** When your repeater malfunctions, or when radio is out of repeater's range, you can continue to communicate in talk around mode. While enable talk around feature, the screen displays: . By this time TX frequency the same as to RX frequency. If switch channel、enable scan feature or restart radio will disable the feature.

Note:

● **To enable this function, TX frequency should be different from RX frequency, and the channel will set as allow talk around on the programming software.**

● **Press the programmed Talk Around key to switch DM mode and RM mode.**

● **VOX:** While this function is enabled, you can enjoy hands-free communication. The radio will automatically begin transmitting when you speaking, and terminate transmitting when you stop talking with no need of PTT press. Allow user to set the VOX level (level 1-9) and VOX delay(0.5~10second) via menu.VOX on indicate by : .

Note: The VOX feature only is used if you are using a supported headphone.

● **Power-on Password:** If enable power-on password feature via programming software, you can modify the password by this menu. First you need input old password correctly, then input a new password twice the same, that will modify the password successfully.

Note: This menu is effective if power on password is set via programming software.

2. Radio Info

With this option, you can view the basic information of your radio, including battery capacity, device ID, firmware version, CP version, and hardware version.

Emergency

The digital channel and digital analog compatible channel support the emergency alarm function. In case of an emergency you can enter emergency mode to ask for help, short press programmed "Emergency on" key to send emergency information, to exit emergency mode, long press "Emergency off". On regular type alarm, after send emergency information then receive ACK command or the alarm cycles expire, the radio will exit the emergency mode automatically. On silent type alarm, after send emergency information the n press PTT key to exit emergency mode.

Via programmable software to set it: Signaling Systems folder → Digital Red Alert → add system1 to set parameters → Channel folder → add Emergency system

- **Emergency Type:** Disable, Regular, Silent, Silent with voice, the Disable option is unable to transmit emergency information;
 - **Emergency Mode:** Emergency Alarm, emergency alarm with call, emergency alarm with voice to follow.
 - **Revert Channel:** Revert channel is used for digital emergency, only the channel default address is set as group call contact, the channel is available for revert channel.
 - **Impolite Retries:** If the current channel is busy, press programmed key also can send emergency information, number of impolite retries can be set as 1 to 15.
 - **Polite Retries:** Only when the current channel is free, press programmed key to send emergency information, number of polite retries can be set as 0 to 14 and endless.
 - **Hot MIC Duration:** If the emergency mode set as emergency alarm with voice to follow, after send emergency information, your voice and background noise to be transmitted automatically as you don't need to press PTT key within hot MIC duration.
- Note: while the short press is set as emergency on, the long press will be set as emergency off default.**

Work Alone

This function is useful for persons who work lonely and encounter an incident; you cannot press any keys or transmit audio within the preset period time. The radio will alarm automatically to ask help. Via the programming software to enable the feature, and setting work alone response time, work alone warn time, work alone response operation.

Via programmable software to set it: Signaling Systems folder→Work Alone→Work Alone Enable→Work Alone Response Time→Work Alone Warn Time→Work Alone Response Operation

Monitor and Permanent Monitor

Monitor: On analog or digital channel, enable the Monitor feature to monitor current channel activities and receive weak signals. Press the programmed Monitor key to

activate the monitor function, if a signal is detected, until the signal is no longer present the radio will exit monitor mode.

Permanent Monitor: Permanent monitor feature is the same as monitor, but long press the Permanent Monitor key to enter monitor mode, the radio will remain on monitor mode until long press it again to exit.

Voice Encryption

The voice encryption can encrypt your audio signals to guarantee the privacy of your communication, via the programming software user can select encryption type as static or dynamic. If the encrypt feature is enabled, the transmitter and receiver will be set as the same encryption type and same voice encryption key, otherwise the receiver is mute.

Via programmable software to set it: General Settings folder →Voice Encryption Type→ Voice Encryption Key

Note: This feature is effective on digital channel, if enable voice encryption feature, the voice encryption key must be 10 characters, there are including letters and numbers.

Battery Saver

This feature allows an idler radio to automatically enter battery saver mode, the mode will extend battery service life, but response time may be delayed. You can set battery saver time ratio as : 1:1、 1: 2、 1:3、 1:4, the time rate is smaller, the power saving more evidently.

Via programmable software to set it: General Setting folder → Battery Saver

Reject Stranger Call

On digital mode, if enable reject strange call feature, while the call ID not exist in the contacts list, it's unable to transmit or receive. When received group call or all call, the device ID of transmitter and group call ID or all call ID should preset on address list.

Via programmable software to set it: General Settings folder →Reject Strange Call

Tone Alerts

Voice Indication

If enable voice indication feature, the radio will give tone indication for channel change, scan feature enable or disable and etc.

Channel Free Indication

On digital mode, if enable Channel Free Indication feature, the receiver gives a high-pitched tone indication while the transmitter release PTT key to stop transmitting.

Talk Permit Indication

There are four options are available for Talk Permit Indication feature: None (the radio does not give any tone indication for transmission on analog and digital channel), Analog (the radio gives tone indication for transmission on analog channel), Analog & Digital (the radio gives tone indication for transmission on analog and digital channel), Digital (the radio gives tone indication for transmission on digital channel).

Via programmable software to set it: General Settings folder → Tone Alerts → Voice Indication → Channel Free Indication → Talk Permit Indication

Lowery Battery Alert

When your battery gets low, LED indicator glows red and with a warning tone: "Please Charge", please replace the battery or charge the battery in time. The radio will turn off automatically while battery is too low.

Via programmable software to set it: General Setting folder → Tone Alerts → RX low battery interval (sec)

Time Out Timer (TOT)

The purpose of TOT is to prevent any user occupy a channel for an extended period. If a channel is busy, the time will be shorter. If the preset time expires, the radio will generate beep and terminate transmission automatically. Via programming software, you can set TOT as 15-495 second.

Via programmable software to set it: Channels folder → Zone → A digital or analog channel → TX Parameters → TOT-TOT Rekey Delay

TX Permission

Digital Channel

This feature can restrict the channel if it is already in use you will be unable to transmit. There are three options available: always, color code free, channel free, if choose always, whenever press PTT key to transmit directly; If choose color code free, you will be unable to transmit on the channel if the color code is already in use; If choose channel free, you will be unable to transmit on the channel if it is already in use. If the channel is busy, press PTT key a low-pitched tone will sound.

Via programmable software to set it: Channels folder → Zone → a digital channel → TX Parameters → Admit Criteria

Analog Channel

This feature can restrict the channel if it is already in use you will be unable to transmit. There are three options available: Off, Carrier, CTCSS/CDCSS, if choose off, whenever press PTT key to transmit directly; If choose carrier, you will be unable to transmit on the channel if the channel is being used by others; If choose CTCSS/CDCSS, you will be unable to transmit on the channel if it is already in use and the CTCSS/CDCSS code in use. If the channel is busy, press PTT key a low-pitched tone will sound.

Via programmable software to set it: Channels folder → Zone → An analog channel → TX Parameters → BCL

Analog Mode

On analog mode, the radio only supports three basic parts to operate, the menu including scan, zone, settings, Voice Records.

- Squelch Level: On the analog mode, this feature allows you to adjust the squelch threshold required for the radio to un-mute. You can set SQL 0~9, Level 3 is set to its basic setting.

Bandwidth

On analog mode, there are two types of bandwidth available, you can choose bandwidth as wide (25 KHz) or narrow (12.5 kHz) via programming software.

Via programmable software to set it: Channel folder → Zone → An analog channel → Bandwidth

CTCSS/CDCSS

On analog channel and digital analog compatible channel, you can set unique CTCSS/CDCSS to guarantee the privacy of your communication, on digital compatible analog or analog compatible digital channel there must have a CTCSS/CDCSS. If CTCSS/CDCSS has been set on the current channel, CTCSS/CDCSS match is required for the radio to receive an incoming signal. You can select a CTCSS/CDCSS from CTCSS frequency table or CDCSS code table, or input non-standard CTCSS/CDCSS manually.

Via programmable software to set it: Channels folder→ Zone→ An analog channel → TX Parameters to select encode→ RX Parameters to select decode

- **Decode:** Only when receiver receives a call containing matching the decode, you can hear the call;
- **Encode:** Signal that you transmit will only be heard by parties whose CTCSS/CDCSS signaling matches your radio's.

Note: The radio approve of non-standard code, on analog mode, you can input non-standard code manually as you need.

CTCSS Standard Frequency Table

CTCSS No.	Freq. [Hz]	CTCSS No.	Freq. [Hz]	CTCSS No.	Freq. [Hz]	CTCSS No.	Freq. [Hz]
1	67.0	11	94.8	21	131.8	31	186.2
2	69.3	12	97.4	22	136.5	32	192.8
3	71.9	13	100.0	23	141.3	33	203.5
4	74.4	14	103.5	24	146.2	34	210.7
5	77.0	15	107.2	25	151.4	35	218.1
6	79.7	16	110.9	26	156.7	36	225.7
7	82.5	17	114.8	27	162.2	37	233.6
8	85.4	18	118.8	28	167.9	38	241.8
9	88.5	19	123.0	29	173.8	39	250.3
10	91.5	20	127.3	30	179.9		

CDCSS Standard Code Table

NO.	Normal	Inverted	NO.	Normal	Inverted	NO.	Normal	Inverted
1	D023N	D023I	29	D174N	D174I	57	D445N	D445I
2	D025N	D025I	30	D205N	D205I	58	D464N	D464N
3	D026N	D026I	31	D223N	D223I	59	D465N	D465N
4	D031N	D031I	32	D226N	D226I	60	D466N	D466I
5	D032N	D032I	33	D243N	D243I	61	D503N	D503I
6	D043N	D043I	34	D244N	D244I	62	D506N	D506I
7	D047N	D047I	35	D245N	D245I	63	D515N	D515I
8	D051N	D051I	36	D251N	D251I	64	D532N	D532I
9	D054N	D054I	37	D261N	D261I	65	D546N	D546I
10	D065N	D065I	38	D263N	D263I	66	D565N	D565I
11	D071N	D071I	39	D265N	D265I	67	D606N	D606I
12	D072N	D072I	40	D271N	D271I	68	D612N	D612I
13	D073N	D073I	41	D306N	D306I	69	D624N	D624I
14	D074N	D074I	42	D311N	D311I	70	D627N	D627I
15	D114N	D114I	43	D315N	D315I	71	D631N	D631I
16	D115N	D115I	44	D331N	D331I	72	D632N	D632I
17	D116N	D116I	45	D343N	D343I	73	D654N	D654I
18	D125N	D125I	46	D346N	D346I	74	D662N	D662I
19	D131N	D131I	47	D351N	D351I	75	D664N	D664I
20	D132N	D132I	48	D364N	D364I	76	D703N	D703I
21	D134N	D134I	49	D365N	D365I	77	D712N	D712I
22	D143N	D143I	50	D371N	D371I	78	D723N	D723I
23	D152N	D152I	51	D411N	D411I	79	D731N	D731N
24	D155N	D155I	52	D412N	D412I	80	D732N	D732N
25	D156N	D156I	53	D413N	D413I	81	D734N	D734I
26	D162N	D162I	54	D423N	D423I	82	D743N	D743I
27	D165N	D165I	55	D431N	D431I	83	D754N	D754I
28	D172N	D172I	56	D432N	D432I			

Specifications

General	
Frequency range	VHF:136-174 MHz UHF:400-480 MHz/450-520 MHz
Channel Capacity	1024
Zones	64
Channel Spacing	12.5KHz/25KHz
Operating Voltage	DC 7.4V (±20%)
Battery Capacity	1800 mAh
Battery Life (5/5/90)	Digital 18 Hours ; Analog 13 Hours
Frequency Stability	±1.5ppm
Antenna Impedance	50Ω
Dimensions (L×W×H)	129 (L) *60(W) * 36(H)mm
Weight	283g(Including Battery)
Transmitter	
RF Output Power	High : 5W ; Middle : 3W ; Low : 1W
4FSK Modulation	12.5kHz Only data : 7K60FXD 12.5kHz data and audio : 7K60FXE
FM Modulation	12.5 kHz : 8K50F3E ; 25 kHz : 16K0F3E ;
Modulation Limiting	+/- 2.5kHz @ 12.5kHz; +/- 5kHz @ 25kHz
FM Noise	-40dB
Conducted Emission	-36 dBm≤1GHz/-30 dBm≥1GHz
Adjacent Channel Power	≤-60dB
Audio Response	+1/-3 dB
Audio Distortion	3%
Digital Voice coder Type	AMBE3000
Receiver	
Digital Sensitivity	5% BER : 0.25 uV
Analog Sensitivity	0.25 uV (12 dB SINAD)
Intermodulation	65dB
Adjacent Channel Selectivity	60 dB
Spurious Response Rejection	70 dB
FM Noise	-40dB
Audio Response	+1/-3 dB
Audio output power	500mW
Audio Distortion	3% (Typical)
Conducted Spurious Emission	-36dBm

Environmental Specifications	
Working Temperature	-20°C—+60°C
Storage Temperature	-30°C—+85°C
Vibration & Shock	MIL-STD-810C/D/E/F Standard

Statement

This manual is deemed to be compiled to be accurate and complete. For any doubt, please contact us. We will give you professional answers. As radio communication technologies develop rapidly, BelFone reserves the right to change product design and specification without prior notice.

Belfone

FUJIAN BELFONE COMMUNICATIONS TECHNOLOGY CO.,LTD.

Add: A-15 Huaqiao Economic Development Zone,
Shuangyang, Luojiang, Quanzhou, Fujian, China

Tel: +86 595 28396717

Fax: +86 595 22771635

Email: overseas@belfone.com

Website: www.belfone.com



RECYCLABLE PACKAGING